

rolly[®] trac lader

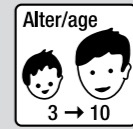

rolly toys Kundendienst Deutschland:

Tel: +49 (0) 95 68 / 856-142
 Fax: +49 (0) 95 68 / 856-183
 e-mail: service@rollytoys.de

2016/11

934.000.800.00

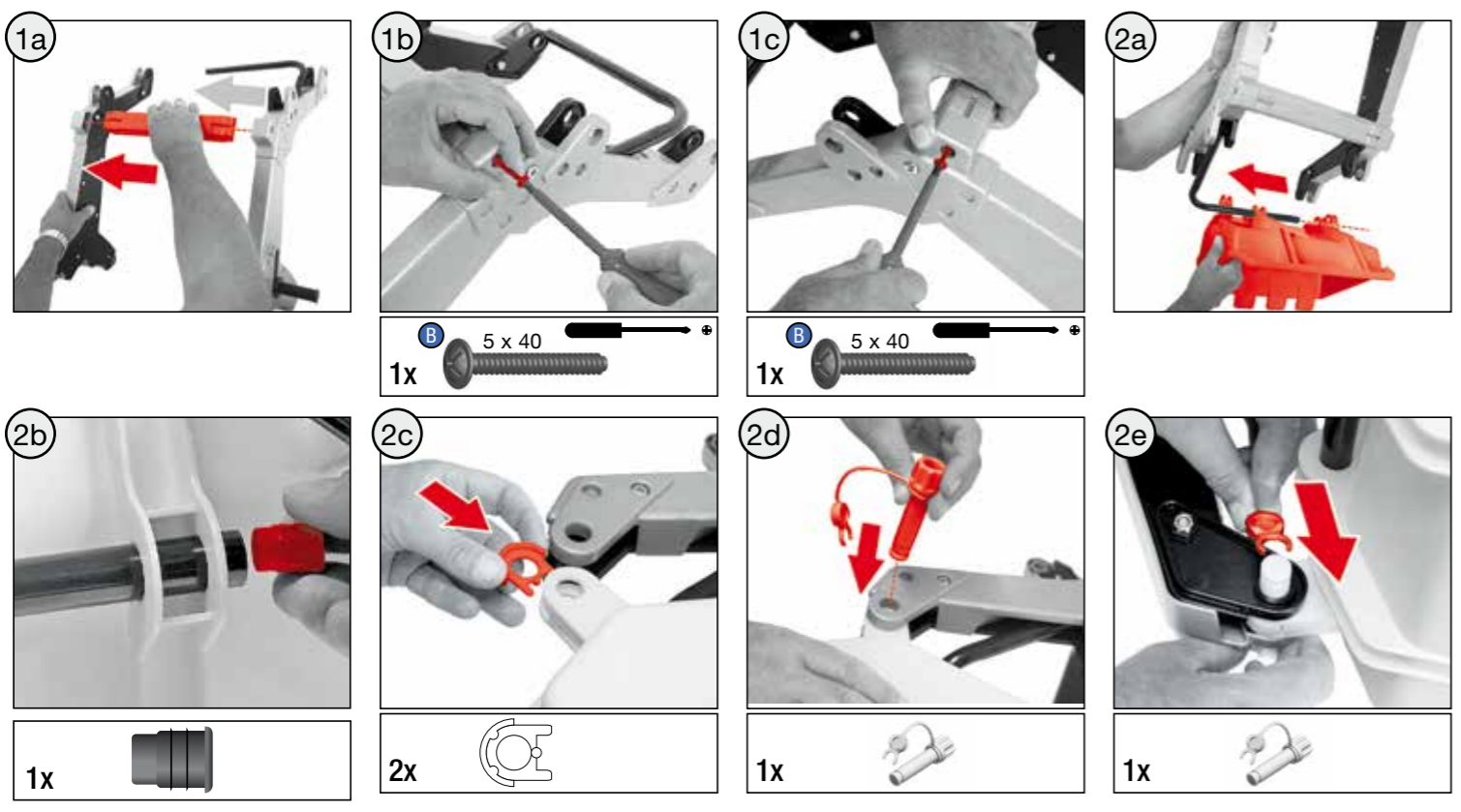

⚠ WARNING

- CHOKING HAZARD - Small parts, Danger of being swallowed. Contains small parts in non assembled state. Must be assembled by adults.
- Toy is not suitable to carry children.
- If toy is defective stop using it, repairs may only be carried out by adults.
- Adult supervision required.
- Never use near steps, slopes, driveways, hills, roadways, alleys or swimming pool areas.
- Always wear shoes.
- Conforms to the requirements of ASTM Standard Consumer Safety Specification on Toy Safety, F 963.

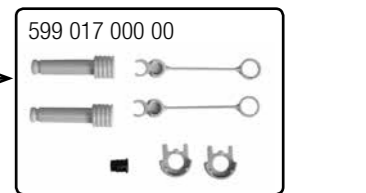
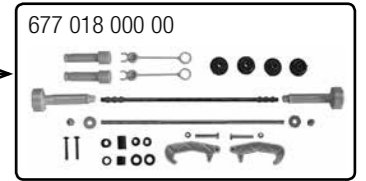
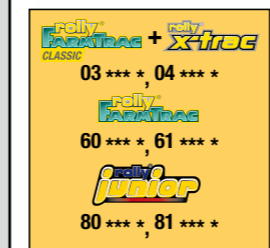
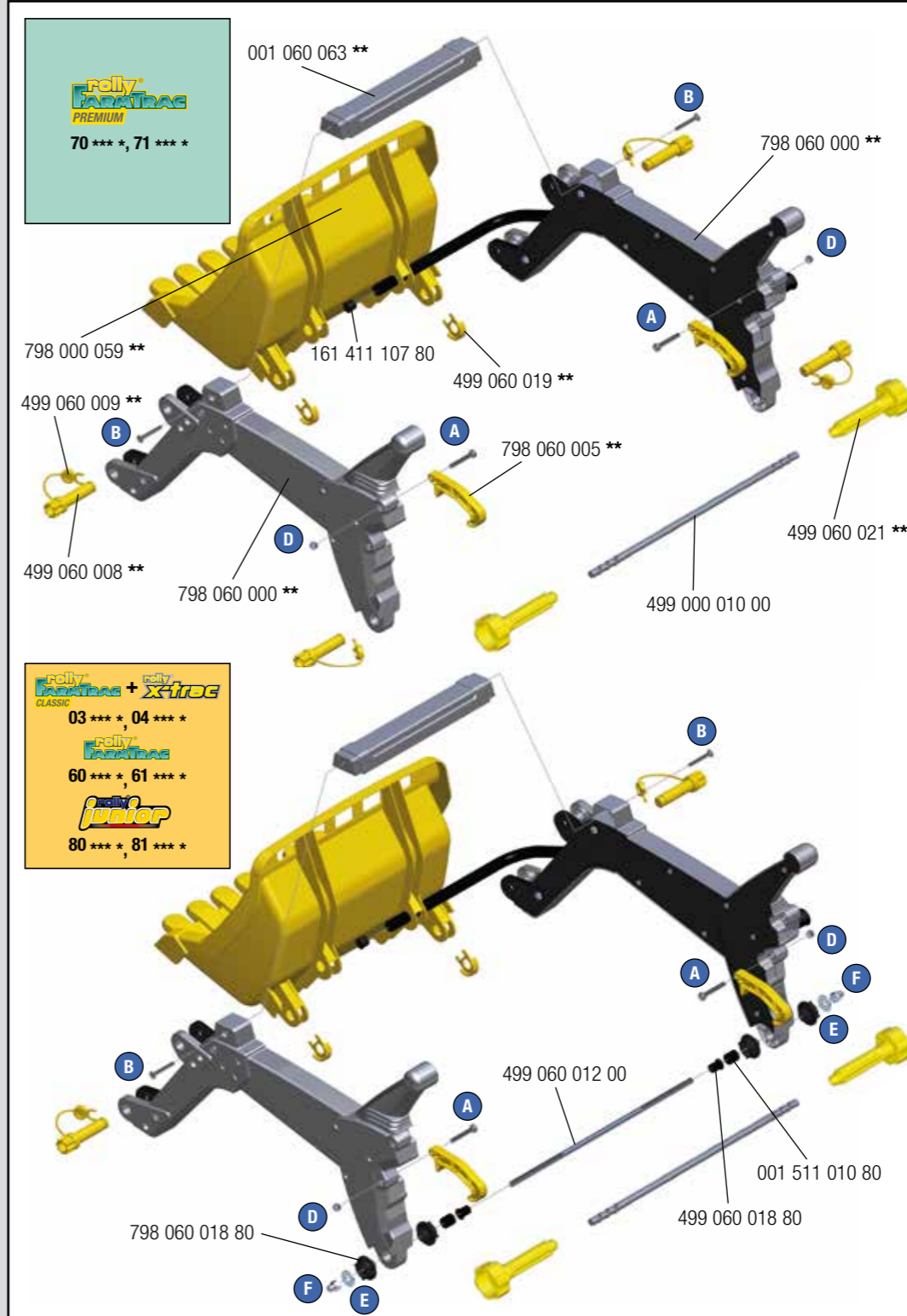

→ **

● +10	● +26	● +47
● +12	● +30	● +51
● +13	● +37	● +54
● +20	● +40	● +70
● +22	● +41	● +75
● +23	● +44	● +80

--- NORTH & SOUTH AMERICA only ---
180 days warranty

From the date of purchase + guaranteed spare part service
 The warranty does not cover damages caused by improper use or neglect



made in Germany



rolly toys
Franz Schneider GmbH & Co KG
 P.O.Box 1460
 D-96459 - Neustadt bei Coburg · Germany
 Tel.: +49 (0) 95 68 / 856-0
 Fax.: +49 (0) 95 68 / 856-190
 www.rollytoys.com

reilly FARATRAC PREMIUM
70 *** , 71 ***
(A - I)

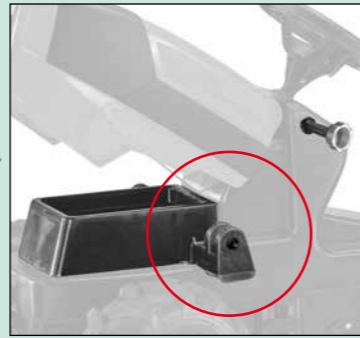
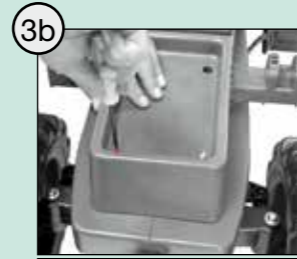
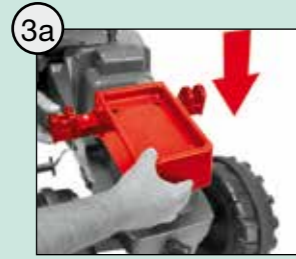

2x **B** 5 x 40
2x **C** 3 x 20

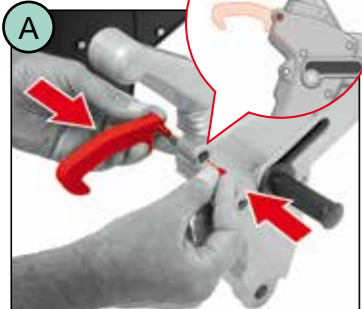

1x **A** M6 x 40
1x **D** M6

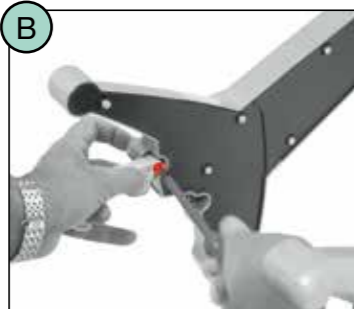

1x

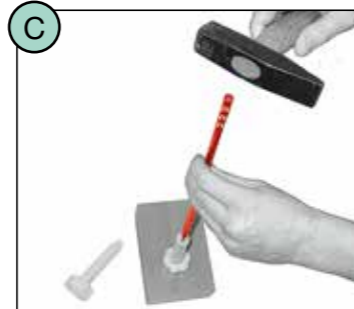

1x $\varnothing 8 \times 335\text{mm}$

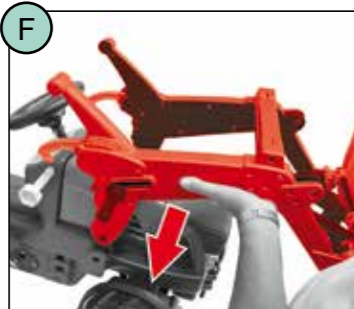
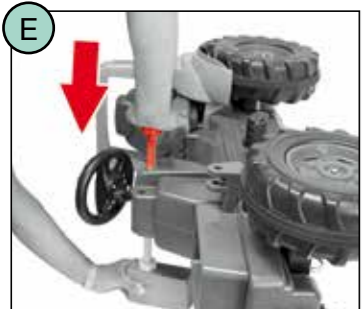
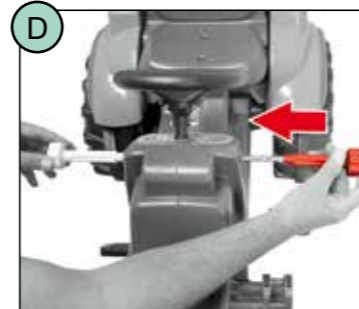

2x

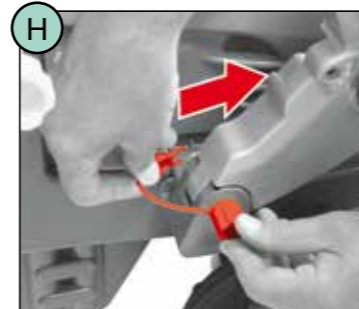

reilly FARATRAC + reilly XTAC CLASSIC
03 *** , 04 ***
reilly FARATRAC
60 *** , 61 ***
reilly junior
80 *** , 81 ***
(J - Z)

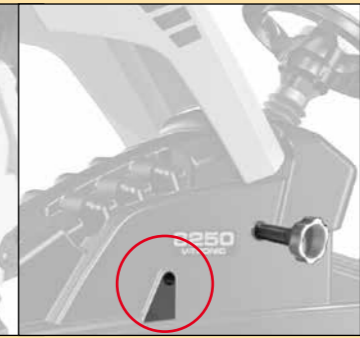
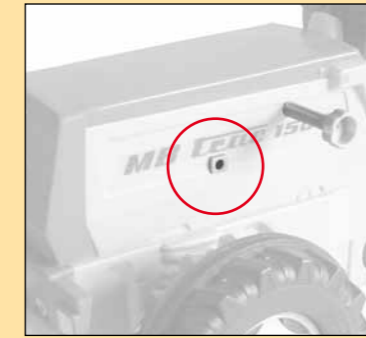

1x **A** M6 x 40
1x **D** M6

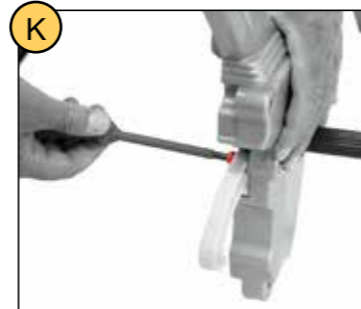

1x



1x $\varnothing 8 \times 335\text{mm}$



1x

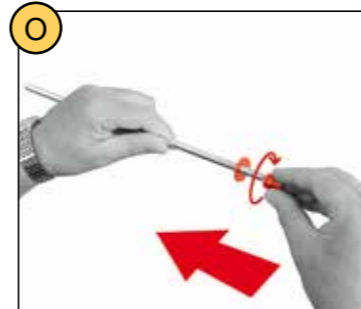
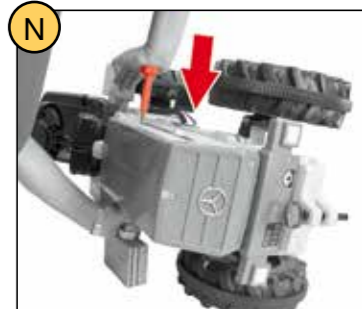

1x $\varnothing 8 \times 345\text{mm}$



2x $\varnothing 12 \times 16\text{mm}$



1x



1x

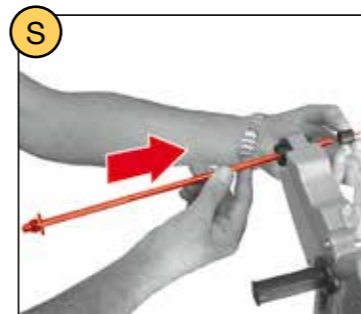

1x

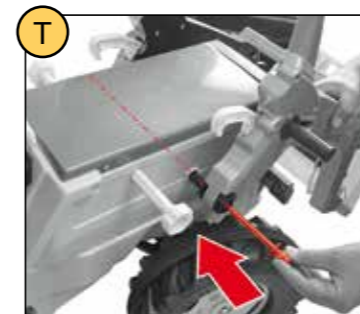

1x

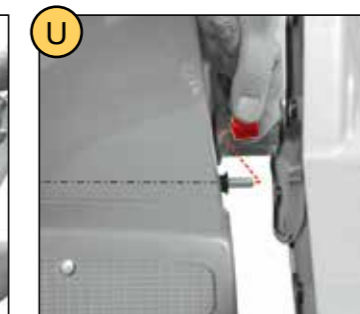

1x

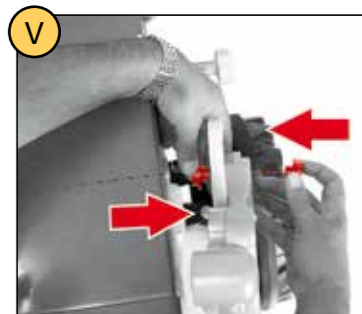

1x

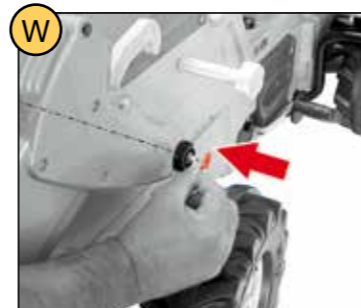

1x **E** $\varnothing 8,4 \times \varnothing 24$

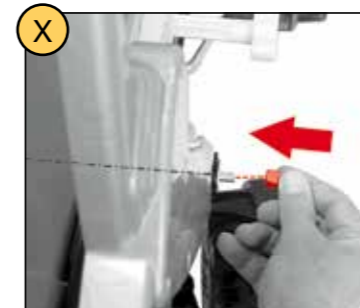

1x **F** M8



1x



A M6 x 40
2x 798 506 040 00

D M6
2x 098 506 000 00

E $\varnothing 8,4 \times \varnothing 24$
2x 902 184 000 00

F M8
2x 098 608 000 00

B AMTEC 5 x 40
2x 520 060 540 00

C $\varnothing 3 \times 20$
2x 750 503 020 00

